

LPTDX1220 – 12-CHANNEL DIMMER PACK

1. Introduction



To all residents of the European Union
Important environmental information about this product



This symbol on the device or the package indicates that disposal of the device after its lifecycle could harm the environment. Do not dispose of the unit (or batteries) as unsorted municipal waste; it should be taken to a specialised company for recycling. This device should be returned to your distributor or to a local recycling service. Respect the local environmental rules.

If in doubt, contact your local waste disposal authorities.

Thank you for buying the LPTDX1220 ! Please read the manual carefully before bringing this device into service.

Maintenance is easy and the LPTDX1220 features 12 DMX channels, dimming and switching modes, modular construction 12 x 20A in 3 phase systems, analogue or DMX control and 0-10V or DMX input.

Make sure that the device was not damaged in transit. If the device is damaged, you should contact your dealer and postpone installation of this device.

2. Safety Instructions



Be very careful when installing the device : touching live wires can cause life-threatening electroshocks.



Do not touch the device during operation as the housing heats up



Protect this device against rain and moisture



Unplug the supply cable before opening the housing

- A qualified technician should install and service this device.
- Damage caused by disregarding certain guidelines in this manual is not covered by the warranty and the dealer will not accept responsibility for the ensuing defects or problems.
- Do not switch the device on immediately if it has been exposed to changes in temperature. Protect the device against damage by leaving it switched off until it has reached room temperature.
- This device falls under protection class I. It is essential, therefore, that the device be earthed. A qualified person must carry out the electric connection.
- Make sure that the available voltage does not exceed the voltage stated in the specifications.

- Do not crimp the power cord and protect it against damage from sharp edges. Ask an authorised dealer to replace the cord if necessary.
- Always disconnect the device from the mains when it is not in use or when you wish to clean it. Only handle the power cord by the plug. Never pull out the plug by tugging the power cord.
- Do not look directly into the light source as sensitive people may go into epileptic seizure if they do.
- Note that damage caused by user modifications to the device is not covered by the warranty. Keep the device away from children and unauthorised users.

3. General Guidelines

- This device is a lighting controller for professional use on stage, in discos, theatres, etc. The LPTDX1220 should only be used indoors with an alternating current of max. 230Vac/50Hz.
- Do not shake the device. Avoid brute force when installing or operating the device.
- Select a location where the device will be protected against extreme heat, moisture and dust.
- Do not use or transport the device under temperatures $< 5^{\circ}\text{C}$ or $> 35^{\circ}\text{C}$.
- Familiarise yourself with the functions of the device before actually using it. Do not permit operation by unqualified people. Any damage that may occur, will probably be due to unprofessional use of the device.
- Use the original packaging if the device is to be transported.
- Note that all modifications of the device are forbidden for safety reasons.
- Do not remove the serial number sticker from the device as doing so will void the warranty. Only use the device for its intended purpose. All other uses may lead to short-circuits, burns, electroshocks, lamp explosion, crash, etc. Using the device in an unauthorised way will void the warranty.

4. Installation

Mount the device in your rack. Connect the spots or light effects to the screw connectors at the back of the device (see figure below : 21-28). Connect your DMX controller to the DMX IN socket with a 5-pole DMX cable. Connect the second device to the DMX OUT of the first device when connecting several LPTDX1220's to your DMX controller. The device will always power on in the mode it was last used.

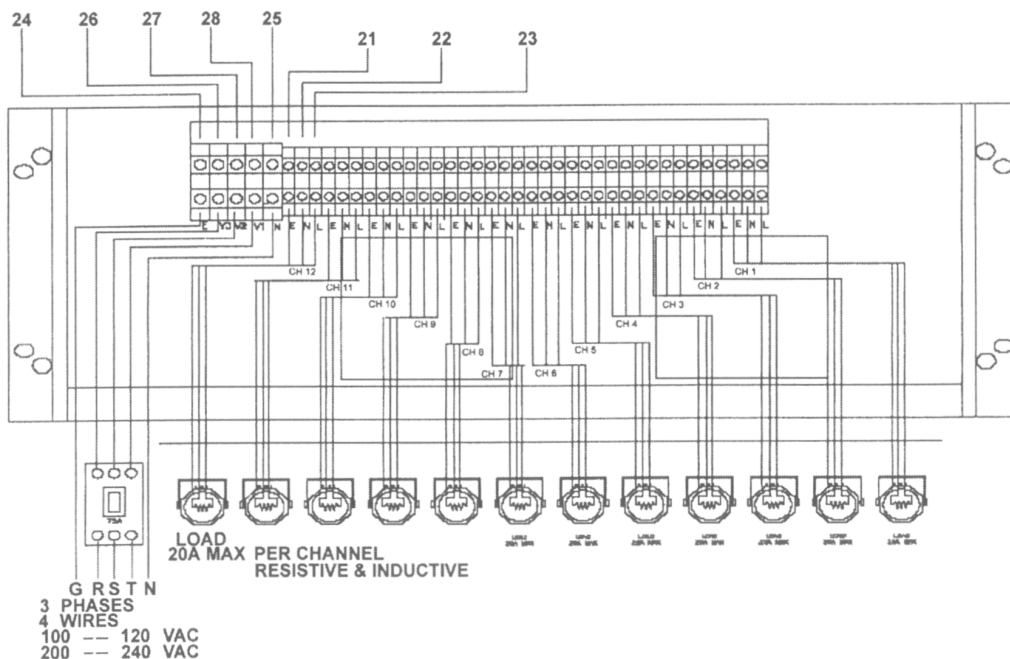

5. Description

a) Front

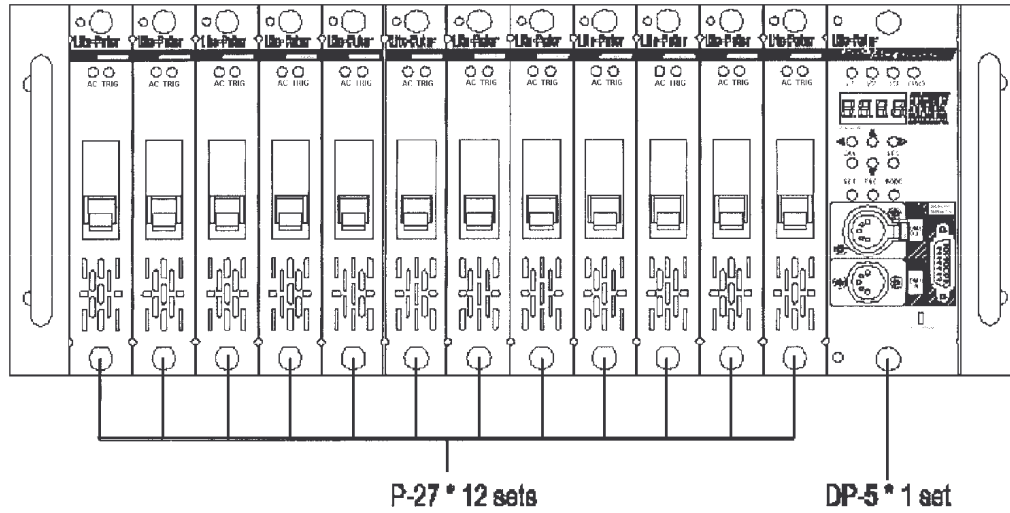

b) Channel Module

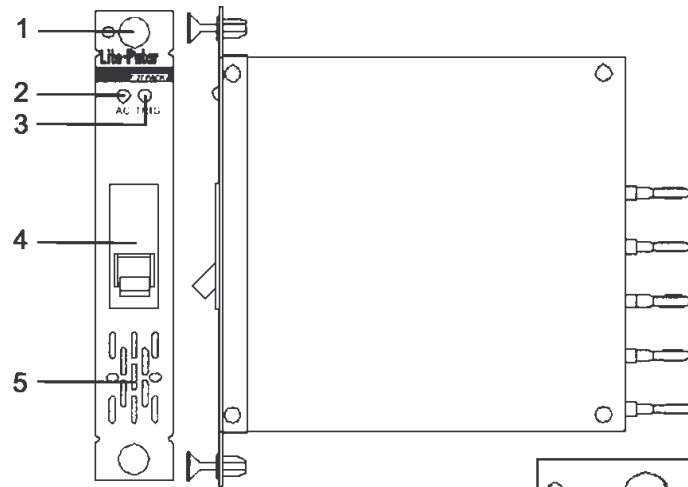

- 1) Locking / unlocking system
- 2) TRIG LED indicator
- 3) AC LED indicator
- 4) 20A automatic fuse
- 5) Ventilation holes

c) DMX interface

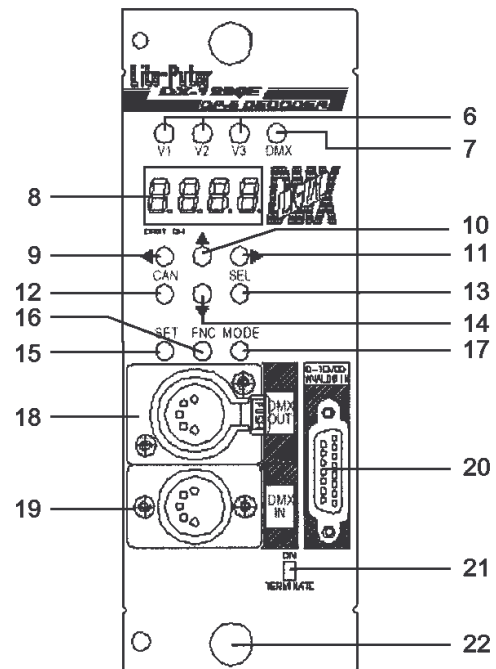

- 6) LED indicators for mains phase
- 7) LED indicator for DMX input
- 8) LED display
- 9) ← key
- 10) ↑ key
- 11) → key
- 12) CANCEL key
- 13) SELECT key

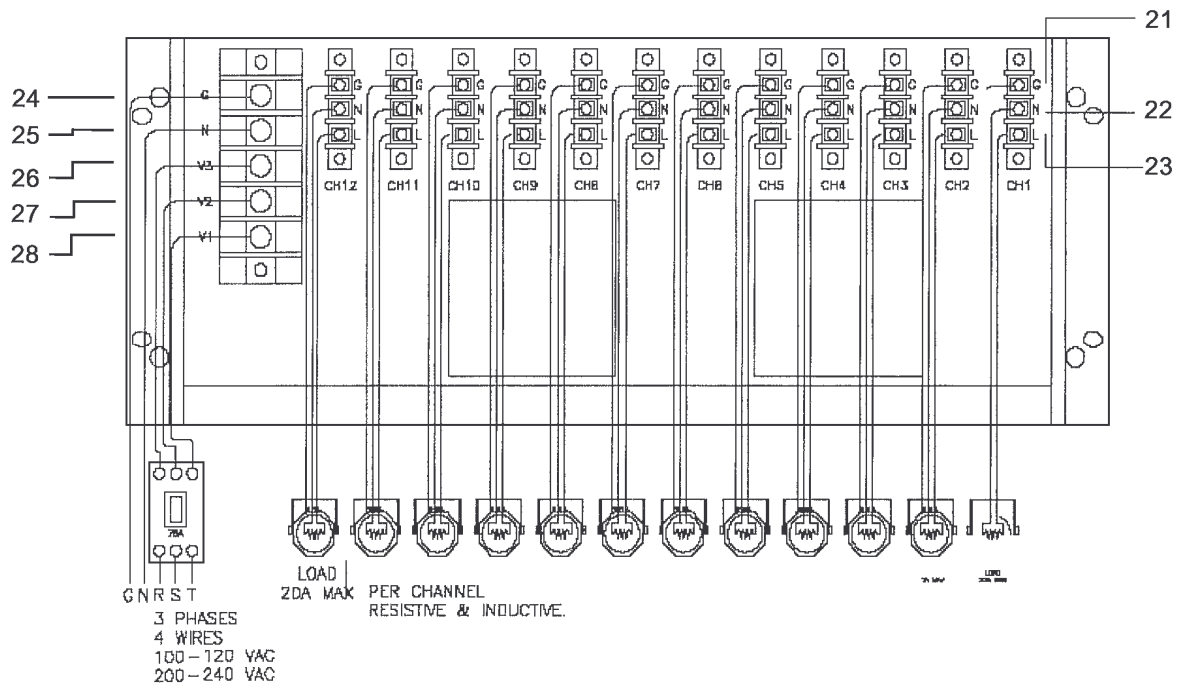
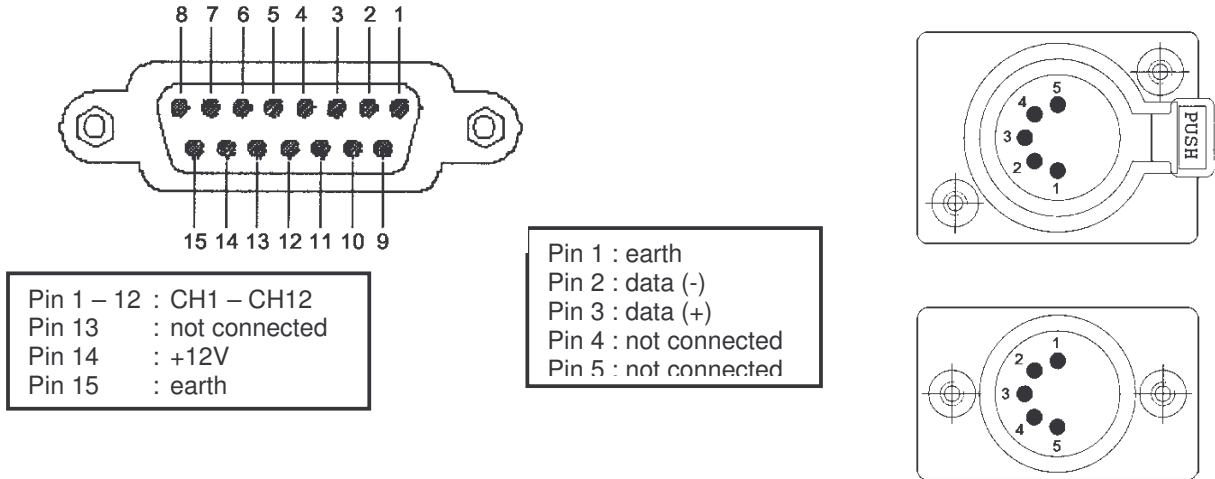

- 14) ↓ key
- 15) SET key
- 16) FUNCTION key
- 17) MODE key
- 18) 5-pin DMX output socket (see detail below)
- 19) 5-pin DMX input socket (see detail below)
- 20) Analogue input socket : 0-10V (see detail below)

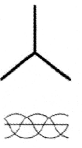
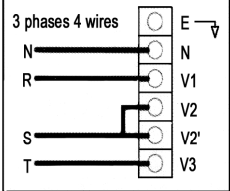
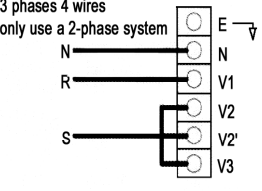
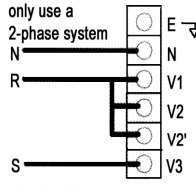
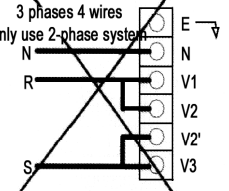
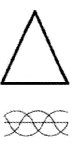
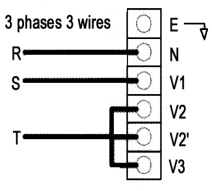
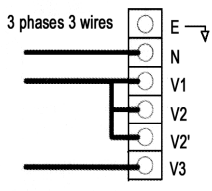
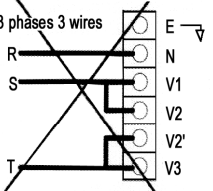
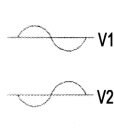
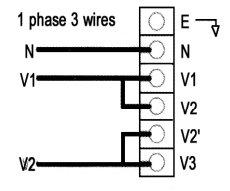

- 21) earth connection
- 22) neutral wire
- 23) positive wire
- 24) earth connection
- 25) mains power wire #1
- 26) mains power wire #2
- 27) mains power wire #3
- 28) neutral wire

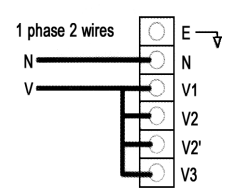
<p>3 phases 4 wires</p> 	<p>THE BEST WIRING DIAGRAM</p> <p>3 phases 4 wires</p>  <p>3 phases 4 wires only use a 2-phase system</p>  <p>3 phases 4 wires only use a 2-phase system</p>  <p>3 phases 4 wires only use a 2-phase system</p> 
<p>3 phases 3 wires</p> 	<p>3 phases 3 wires system is not suitable for lighting purposes (see diagram on the far right). The other two diagrams are suitable.</p> <p>3 phases 3 wires</p>  <p>3 phases 3 wires</p>  <p>3 phases 3 wires</p> 
<p>single phase 3 wires</p> 	<p>used with single-phase systems only</p> <p>1 phase 3 wires</p>  <p>used for single-phase only (special design for Japanese market)</p>
<p>single phase 2 wires</p> 	<p>1 phase 2 wires</p> 
<p>NOTE</p>	<p>*** V2 AND V2' SHOULD ALWAYS BE CONNECTED TO THE SAME PHASE</p>

6. Operating Instructions

Upon activation, the device will be in the last mode it was functioning before power off. Press the MODE button to select the next mode and the LED display will show the chosen mode. A selected but unconfirmed mode will have dots between the letters on the display. Press the SEL button to confirm the selected mode.

MODE 1 : DMX
 MODE 2 : ANALOGUE
 MODE 3 : OFF

Functions and Settings

After selecting the desired mode, select the desired function by pressing FUN and different settings by pressing SET. Again, dots between the letters on the display indicate a temporary setting.

FUNCTION 1 : MONITOR
 FUNCTION 2 : TEST
 FUNCTION 3 : AUTOMATIC FADER TEST

SETTING 1 : PREHEATING
SETTING 2 : DIMMED / SWITCHED
SETTING 3 : SCENE PROGRAMMING
SETTING 4 : SET FADER TIME
SETTING 5 : LIST OF FADER TIMES
SETTING 6 : SET SQUARE LAW OR LINEAR DIMMING CURVE
SETTING 7 : SETTING MAXIMUM OUTPUT WATTAGE

Locking the keyboard : Press MODE + FUN + ↓ simultaneously
Unlocking the keyboard : Press MODE + FUN + ↑ simultaneously

Three Different Modes

Mode 1 : DMX

The display reads :

d001 → d512

d = DMX

001 – 512 = DMX start addresses

← : decrease the DMX start address of a channel
→ : increase the DMX start address of a channel
↑ : increase the DMX start address by 12
↓ : reset to d001
SEL : confirms the selected channel
SET : access to different settings
CAN : cancels current operation and return to the previous confirmed one
MODE : switch to analogue mode

Assign a start address to each LPTDX1220 when connecting multiple LPTDX1220's to a DMX control panel. This address determines the channels used by each LPTDX1220.

Example :

Device #1 : start address = d001, DMX channels used : 01 - 12

Device #2 : start address = d013, DMX channels used : 13 - 24

Device #3 : start address = d025, DMX channels used : 25 - 36

A resistor should terminate the DMX connection. Put the ON/TERMINATE selector in the ON position.

Mode 2 : Analogue

The display reads :

AE12

SEL : Confirms analogue mode

CAN : Cancels the current operation and returns to the last confirmed operation

MODE : Change to OFF mode

Mode 3 : OFF

The display reads :

AE12

SEL : Confirms OFF mode

CAN : Cancels the current operation and returns to the last confirmed operation

MODE : Change to DMX mode

Three Different Functions

Function 1 : Monitor

The display reads :

010.0 → 129.9

01 – 12 = channels

0.0 – 9.9 = settings of a channel

Settings can be done per channel automatically or manually.

Automatic setting : the display shows the settings of each channel.

Manual setting : to select channels separately. Can be used to change channels while in chaser mode.

← : decrease by one channel

→ : increase by one channel

SET : switch to different settings

CAN : cancels current operation and returns to the previous confirmed one

MODE : change to analogue mode

FUN : change to TEST function

Function 2 : TEST

The display reads :

EA.00 → 01.00 ... 12.99

tA = test all channels
01 – 12 = channels
.00 - .99 = level per channel

← : decrease by one channel
→ : increase by one channel
↑ : increase the output level of a channel. Starts the test mode.
↓ : decrease the output level of a channel. Starts the test mode
SEL : the output level of all the channels will be set to the chosen value.
SET : switch to different settings
CAN : push once : resets all levels to zero
push twice : cancels current operation and returns to the previous confirmed mode.
MODE : switch back to the last confirmed mode
FUN : switch to “automatic fader test”

Function 3 : AUTOMATIC FADER TEST

The display reads :

A.F.A.L. → A.F.0.1---A.F.1.2

AF = automatic fader test
01 - 12 = channels
AL = all channels

← : decrease the output level of a channel
→ : increase the output level of a channel
↑ : maintains the output level of the channel at 100% as long as the key is pressed
↓ : maintains the output level of the channel at 0% as long as the key is pressed
SEL : starts the test procedure
SET : switch to different settings
CAN : push once : resets all levels to zero
push twice : cancels current operation and returns to the previous confirmed mode.
MODE : switch back to the last confirmed mode
FUN : switch to “monitor function”

Seven Different Settings

Setting 1 : Preheating

The display reads :

AL.0.0 → AL.6.0 → 01.0.0 --- 12.6.0

AL = all channels
01 – 12 = channels
0.0 – 6.0 = preheating level of the dimmer from 0-6%

← : decrease one channel
 → : increase one channel
 ↑ : increase the preheating level
 ↓ : decrease the preheating level
 SET : change to DIMMED/SWITCHED setting
 CAN : cancels current operation and returns to the previous confirmed one
 MODE : switch back to the last confirmed mode
 FUN : switch to different functions

Setting 2 : Dimmed / Switched

The display reads :

AL=d → 01=d → 12=d
AL=S → 01=S → 12=S

AL = all channels
 01 – 12 = channels
 d = dimmed
 S = switched

- - = combination of “dimmed” and “switched” (only possible when the channels have been set as “dimmed” or “switched”)

← : decrease one channel
 → : increase one channel
 ↑ : change from dimmed to switched
 ↓ : change from switched to dimmed
 SET : change to SCENE PROGRAMMING setting
 CAN : cancels current operation and returns to the previous confirmed one
 MODE : switch back to the last confirmed mode
 FUN : switch to different functions
 SEL : memorise the setting

Setting 3 : Scene Programming

The display reads :

SC = 0

Six scenes can be stored in the memory.

Press ► : SC = 1 → SC = 2 → SC = 3 → SC = 4 → SC = 5 → SC = 6
 Press ◀ : SC = 6 → SC = 5 → SC = 4 → SC = 3 → SC = 2 → SC = 1

Connect the LPTDX1220 with your dimming console (DMX/analogue) or use the self-test function of the LPTDX1220. Subsequently, you should select SC=0 or SC=1 --- SC=6

Press SEL to confirm.

SC=0 is executed automatically when the device is activated.
Read "Setting 4" below if you want to change the fade-in / fade-out time.

Setting 4 : Setting the Fader Time

F F F F

Set the fader time (Read "Setting5" below)

—

— =all channels

1 =1st channel

2 =2nd channel

3 =3rd channel

4 =4th channel

5 =5th channel

6 =6th channel

7 =7th channel

8 =8th channel

9 =9th channel

A =10th channel

B =11th channel

C =12th channel

Press ► to increase channels

Press ◀ to decrease channels

Press ▲ to extend the fader time

Press ▼ to shorten the fader time

Press SEL to confirm

Setting 5 : List of Fader Times

set	50Hz	60Hz	set	50Hz	60Hz	set	50Hz	60Hz	set	50Hz	60Hz	set	50Hz	60Hz	set	50Hz	60Hz	set	50Hz	60Hz	set	50Hz	60Hz
00	NoFade	NoFade	20	01'22	01'08	40	02'43	02'16	60	04'05	03'24	80	05'37	04'41	A0	12'25	10'21	C0	19'13	16'01	E0	26'01	21'41
01	00'03	00'02	21	01'24	01'10	41	02'46	02'18	61	04'07	03'26	81	05'49	04'51	A1	12'37	10'31	C1	19'25	16'11	E1	26'13	21'51
02	00'05	00'04	22	01'27	01'12	42	02'48	02'20	62	04'10	03'28	82	06'02	05'02	A2	12'50	10'42	C2	19'38	16'22	E2	26'26	22'02
03	00'08	00'06	23	01'29	01'14	43	02'51	02'22	63	04'12	03'30	83	06'15	05'12	A3	13'03	10'52	C3	19'51	16'32	E3	26'39	22'12
04	00'10	00'09	24	01'32	01'17	44	02'53	02'25	64	04'15	03'33	84	06'28	05'23	A4	13'16	11'03	C4	20'04	16'43	E4	26'52	22'23
05	00'13	00'11	25	01'34	01'19	45	02'56	02'27	65	04'18	03'35	85	06'40	05'34	A5	13'28	11'14	C5	20'16	16'54	E5	27'04	22'34
06	00'15	00'13	26	01'37	01'21	46	02'59	02'29	66	04'20	03'37	86	06'53	05'44	A6	13'41	11'24	C6	20'29	17'04	E6	27'17	22'44
07	00'18	00'15	27	01'39	01'23	47	03'01	02'31	67	04'23	03'39	87	07'06	05'55	A7	13'54	11'35	C7	20'42	17'15	E7	27'30	22'55
08	00'20	00'17	28	01'42	01'25	48	03'04	02'33	68	04'25	03'41	88	07'19	06'06	A8	14'07	11'46	C8	20'55	17'26	E8	27'43	23'06
09	00'23	00'19	29	01'45	01'27	49	03'06	02'35	69	04'28	03'43	89	07'31	06'16	A9	14'19	11'56	C9	21'07	17'36	E9	27'55	23'16
0A	00'26	00'21	2A	01'47	01'29	4A	03'09	02'37	6A	04'30	03'45	8A	07'44	06'27	AA	14'32	12'07	CA	21'20	17'47	EA	28'08	23'27
0B	00'28	00'23	2B	01'50	01'31	4B	03'11	02'39	6B	04'33	03'47	8B	07'57	06'37	AB	14'45	12'17	CB	21'33	17'57	EB	28'21	23'37
0C	00'31	00'26	2C	01'52	01'34	4C	03'14	02'42	6C	04'35	03'50	8C	08'10	06'48	AC	14'58	12'28	CC	21'46	18'08	EC	28'34	23'48
0D	00'33	00'28	2D	01'55	01'36	4D	03'16	02'44	6D	04'38	03'52	8D	08'22	06'59	AD	15'10	12'39	CD	21'58	18'19	ED	28'46	23'59
0E	00'36	00'30	2E	01'57	01'38	4E	03'19	02'46	6E	04'41	03'54	8E	08'35	07'09	AE	15'23	12'49	CE	22'11	18'29	EE	28'59	24'09
0F	00'38	00'32	2F	02'00	01'40	4F	03'21	02'48	6F	04'43	03'56	8F	08'48	07'20	AF	15'36	13'00	CF	22'24	18'40	EF	29'12	24'20
10	00'41	00'34	30	02'02	01'42	50	03'24	02'50	70	04'46	03'58	90	09'01	07'31	B0	15'49	13'11	D0	22'37	18'51	F0	29'25	24'31
11	00'43	00'36	31	02'05	01'44	51	03'27	02'52	71	04'48	04'00	91	09'13	07'41	B1	16'01	13'21	D1	22'49	19'01	F1	29'37	24'41
12	00'46	00'38	32	02'08	01'46	52	03'29	02'54	72	04'51	04'02	92	09'26	07'52	B2	16'14	13'32	D2	23'02	19'12	F2	29'50	24'52
13	00'48	00'40	33	02'10	01'48	53	03'32	02'56	73	04'53	04'04	93	09'39	08'02	B3	16'27	13'42	D3	23'15	19'22	F3	30'03	25'02
14	00'51	00'43	34	02'13	01'51	54	03'34	02'59	74	04'56	04'07	94	09'52	08'13	B4	16'40	13'53	D4	23'28	19'33	F4	30'16	25'13
15	00'54	00'45	35	02'15	01'53	55	03'37	03'01	75	04'58	04'09	95	10'04	08'24	B5	16'52	14'04	D5	23'40	19'44	F5	30'28	25'24
16	00'56	00'47	36	02'18	01'55	56	03'39	03'03	76	05'01	04'11	96	10'17	08'34	B6	17'05	14'14	D6	23'53	19'54	F6	30'41	25'34
17	00'59	00'49	37	02'20	01'57	57	03'42	03'05	77	05'03	04'13	97	10'30	08'45	B7	17'18	14'25	D7	24'06	20'05	F7	30'54	25'45
18	01'01	00'51	38	02'23	01'59	58	03'44	03'07	78	05'06	04'15	98	10'43	08'56	B8	17'31	14'36	D8	24'19	20'16	F8	31'07	25'56
19	01'04	00'53	39	02'25	02'01	59	03'47	03'09	79	05'09	04'17	99	10'55	09'06	B9	17'43	14'46	D9	24'31	20'26	F9	31'19	26'06
1A	01'06	00'55	3A	02'28	02'03	5A	03'50	03'11	7A	05'11	04'19	9A	11'08	09'17	BA	17'56	14'57	DA	24'44	20'37	FA	31'32	26'17
1B	01'09	00'57	3B	02'30	02'05	5B	03'52	03'13	7B	05'14	04'21	9B	11'21	09'27	BB	18'09	15'07	DB	24'57	20'47	FB	31'45	26'27
1C	01'11	01'00	3C	02'33	02'08	5C	03'55	03'16	7C	05'16	04'24	9C	11'34	09'38	BC	18'22	15'18	DC	25'10	20'58	FC	31'58	26'38
1D	01'14	01'02	3D	02'36	02'10	5D	03'57	03'18	7D	05'19	04'26	9D	11'46	09'49	BD	18'34	15'29	DD	25'22	21'09	FD	32'10	26'49
1E	01'17	01'04	3E	02'38	02'12	5E	04'00	03'20	7E	05'21	04'28	9E	11'59	09'59	BE	18'47	15'39	DE	25'35	21'19	FE	32'23	26'59
1F	01'19	01'06	3F	02'41	02'14	5F	04'02	03'22	7F	05'24	04'30	9F	12'12	10'10	BF	19'00	15'50	DF	25'48	21'30	FF	32'36	27'10

Setting 6 : Install dimming curve C2 or C3

Dimming curve C2 :

Indicates the linear relationship between the position of the slide control and the output power.

C = 2

Dimming curve C3 :

More suited for stage lighting. The output power value and the control value (position of the slide control) are directly proportional, yielding a more flexible control range in case of low luminous intensity. This is why professionals prefer dimming curve C3.

C = 3

Press ▲ : change dimming curve
Press ▼ : change dimming curve
Press SEL to confirm

Note that the factory setting is C3.

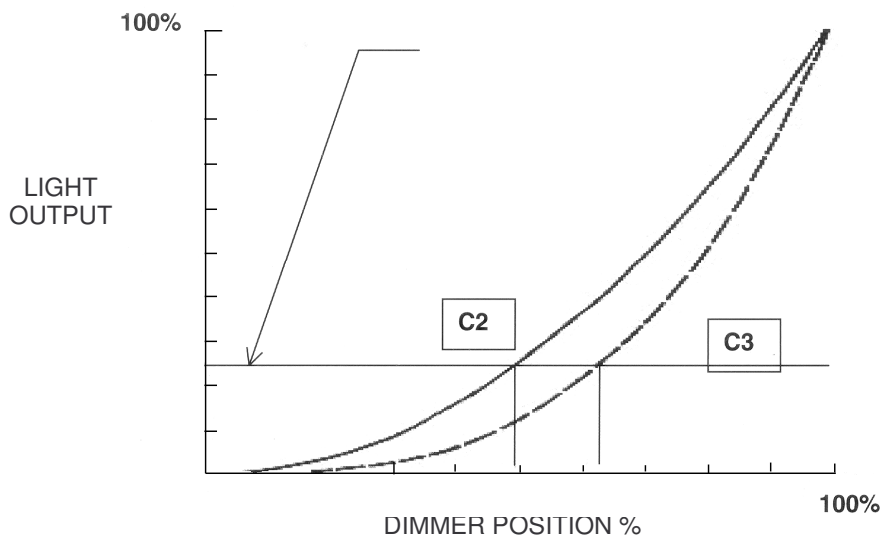

Our eyes are most sensitive to low luminous intensity, in particular to the range that lies below 25% of maximum luminous intensity (100%). Therefore, using C3 yields a more flexible control range.

Setting 7 : Setting the Maximum Output Power Limit

L E F F

This is the max. output power control (from 50% --- FF% (100%))

—

— =all channels

1 =1st channel

2 =2nd channel

3 =3rd channel

4 =4th channel

5 =5th channel

6 =6th channel

7 =7th channel

8 =8th channel

9 =9th channel

A =10th channel

B =11th channel

C =12th channel

Press ► to increase channels

Press ◀ to decrease channels

Press ▲ to increase the max. output power

Press ▼ to diminish the max. output power

Press SEL to confirm

When a channel is set as a non-dimming channel, it doesn't have a preheat function and a you cannot install a max. output power output wattage limit setting function.

The factory setting is **FF** for all channels, which means "100% output".

7. Cleaning and Maintenance

1. All screws should be tightened and free of corrosion.
2. The housing, mounting supports and connections should not be modified or tampered with e.g. do not drill extra holes in mounting supports, do not change the location of the connections, ...
3. The electric power supply cables should be undamaged. Have this device installed by a qualified technician.

8. Caution

- Disconnect the device from the mains prior to maintenance.
- Use a moist cloth to clean the device and avoid the use of alcohol or solvents for cleaning purposes.
- Spare parts should be ordered with your local dealer.

9. Technical Specifications

Power Supply	230Vac/50Hz
Number of channels	12
DMX input & output	5-pin XLR socket
Analogue Output	15-pin SUB-D
Max. Current	20A per channel
Dimensions	482 x 176 x 260mm
Weight	16kg

The information in this manual is subject to change without prior notice.